

# Lined Midsplit Ball Valve

Patent No.: ZL201420018107.4  
YFM ZQ41PFA/FEP



## ✂Product Description

- Youfumi lined midsplit ball valve adopts fluorine plastic as liner and equipped with new type structure of the ball integrated with stem, as well as the unique elastic lip type sealing seat structure to provide itself all the advantages of general ball valve.
- It offers much lower torques and being one of the most accepted and popular valve types.
- It offers economical solutions for the vast majority of chemical applications while maintaining the highest possible degree of performance in terms of in-line leakage.
- They are commonly used in chlor-alkali, industrial in organic chemicals, metal and mining, nitrogen and phosphatic fertilizers, petroleum refining, pharmaceutical, and have superior performance in: chlorine, benzene, bromine, sulfuric acid, nitric acid, hydrochloric acid, phosphoric acid, sea water etc.



# A Lined Valve

## Lined Midsplit Ball Valve



### ※ Technical Specification

Design & Manufacture Standard		HG/T 3704, GB/T 12237	API 6D	
Face-to-face Dimension Standard		HG/T 3704, GB/T 12221	ASME B16.10	
Flange Standard		HG/T 20592, GB/T 9119	ASME B16.5, JIS B2220	
Inspection & Test Standard		GB/T 13927, JB/T 9092	API 598	
Nominal Diameter		DN15~DN350	1/2"~14"	
Nominal Pressure (MPa)		1.0	1.6	150Lb
Pressure Test (MPa)	Shell Test	1.5	1.5	1.5
	High Pressure Sealing	1.1	1.1	1.1
	Low Pressure Sealing	0.6	0.6	0.6
Temperature Range(°C)		PFA: -30~200	FEP: -30~150	GXPO: -10~80
Applicable Medium		Strong corrosive medium i.e. hydrochloric acid, Nitric acid, Hydrofluoric acid, Liquid chlorine, Sulfuric Acid and Aqua regia etc.		

### ※ Structure Features

#### ◆ New handle design

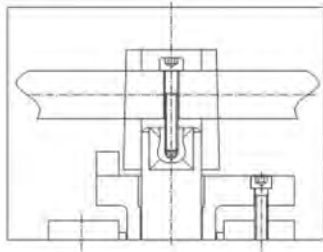

Handle designed to be movable from the operating rod, which can be adjusted to lengthen the rod. Or handle can be fixed on the operating rod to prevent from falling off. Handle seat and locating plate adopt the integral casting molding design, to get rid of traditional fission design, is more convenient for installation and positioning adjustment.

#### ◆ Lower torque

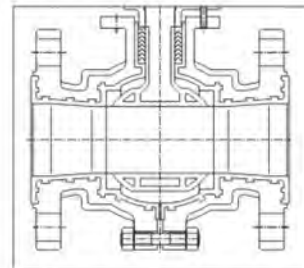

Because of midsplit body, the force on seat can be balanced on left and right side, to avoid uneven stress on body and displacement of ball. The ball is contact with a much smaller surface (seat rings). Consequently the operating torque is much lower, reducing costs, space and weight saving.

#### ◆ For vacuum service

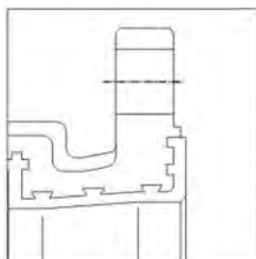

Processing dovetail groove in metal body in which lining locked to resists shrinkage, collapse and blow-out, to strengthen the adhesion between body and liner, ensuring the valve operated in the condition of slight negative pressure and full vacuum.

#### ◆ Design of less leakage point

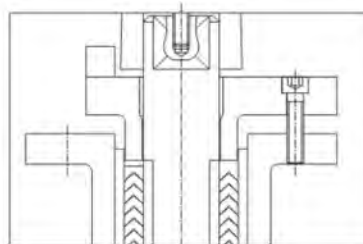

Valve body takes design of stuffing box to replace the fission structure to reduce the leakage point.

#### ◆ ISO 5211 platform design

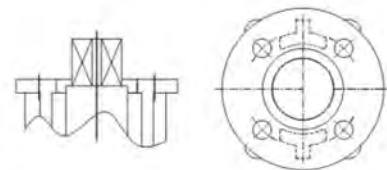

This new type ball valve with high platform fully compliance with ISO 5211 standard, allowing use of standard mounting kits. Nice appearance and tight configuration.



# A Lined Valve

## Lined Midsplit Ball Valve



### ※ Pressure-Temperature Curve

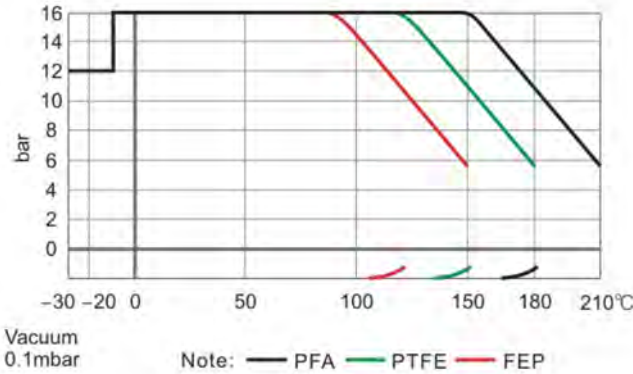

### ※ Flow Characteristic

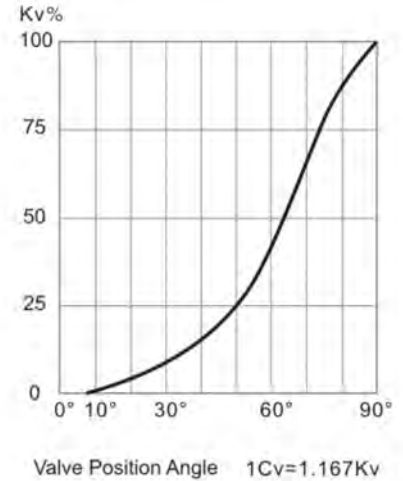

### ※ Instruction

◆ When examine and repair lined ball valve, shut off cut-off valve in front of lined ball valve before open it, and then release the pressure on ball valve body completely, because when ball valve in the closed state, there remain part of medium and pressure in body. If it is electric or pneumatic lined ball valve, disconnect the power and air supply before examine and repair.

Be careful to prevent PTFE seat from damage which would result in leakage when disassemble the ball valve if need to clean it.

When assemble or disassemble the lined ball valve, body bolts and nuts should be fixed and then tighten all nuts to fix at the same time. Otherwise uneven force from nuts will cause damage on flange surface, leading leakage.

When clean the valve, do not choose the solvent that will corrode or react to the valve parts. When cleaning, thoroughly clean the traces of dirt, grease and other attached objects. If cannot clean with water, under the condition of no damage to the valve body and component, clean it with alcohol and then waiting for the solvent completely evaporated before assembly.

If there is a little leakage in packing position, tighten the stem nut until no leaking and no need to further tighten.

If valves stored in outdoor for a long time, it can lead to valve parts rust and increase the possibility of liner expansion or shrink. Therefore, ball valve must store indoor, or should be rainproof, waterproof, moisture proof and the flange should be protected by cover.

If the lined ball valve stored for more than 12 months, it should be retested to ensure stable performance before installing in line.

◆ If there is a little leakage in packing position, tighten the stem nut, close the leakage and do not continue to tighten.

◆ Stored in outdoor for a long time can lead to valve parts rust, cannot used as normal. Ball valve storage should be rainproof, waterproof, moisture proof, and the flange cover should be tight.

◆ Fluorine plastic lined valves stored for more than 12 months should be retested to ensure stable performance before used.

**A** Lined Valve  
**Lined Midsplit Ball Valve**

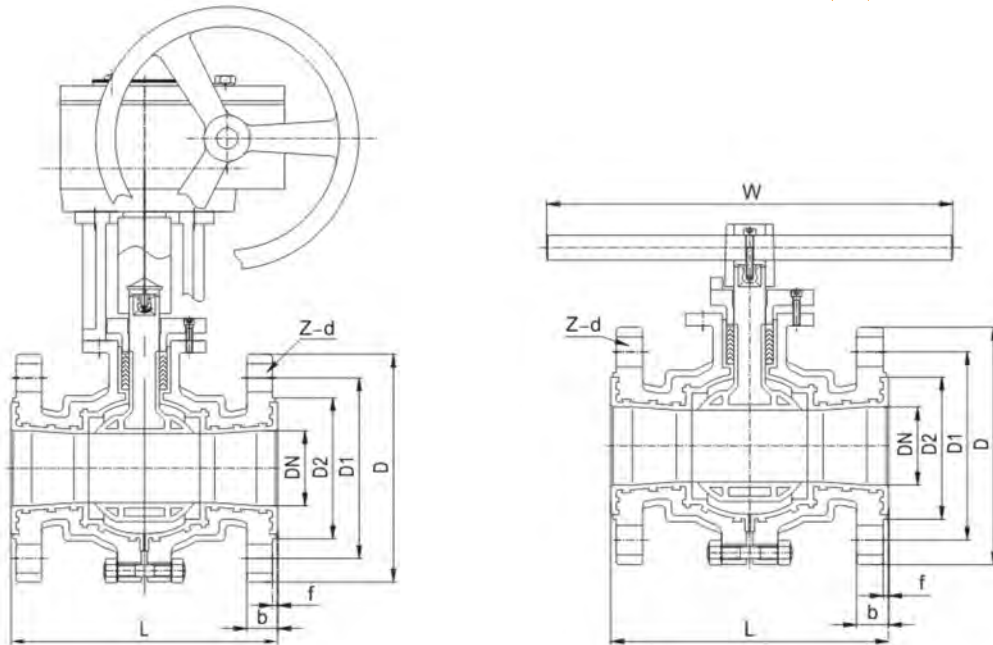

**HG/T 20592 PN10/PN16**

Unit:mm

DN	L	D	D1	D2	Z-d	f	b	H	W	H1
15	132	95	65	45	4-14	2	15	140	100	-
20	142	105	75	55	4-14	2	16	160	105	-
25	150	115	85	65	4-14	2	16	200	110	-
32	165	140	100	78	4-18	3	16	200	130	-
40	180	150	110	85	4-18	3	17	220	135	-
50	200	165	125	100	4-18	3	18	220	145	-
65	220	185	145	120	4-18	3	20	350	155	-
80	250	200	160	135	8-18	3	22	400	210	340
100	280	220	180	155	8-18	3	24	400	235	360
125	320	250	210	185	8-18	3	26	550	255	405
150	360	285	240	210	8-22	3	28	550	285	425

**ASME B16.5 Class150**

Unit:mm

DN	L	D	D1	D2	Z-d	f	b	H	W	H1
1/2	110	89	60.5	35	4-16	2	12	100	140	-
3/4	117	98	70.0	43	4-16	2	12	105	160	-
1	127	108	79.5	51	4-16	2	12	110	200	-
1 1/4	140	117	89.0	64	4-16	2	13	130	200	-
1 1/2	165	127	98.5	73	4-16	2	15	135	220	-
2	178	152	120.5	92	4-19	2	16	145	220	-
2 1/2	190	178	139.5	105	4-19	2	18	155	350	-
3	203	190	152.5	127	4-19	2	19	210	400	340
4	229	229	190.5	157	8-19	2	24	235	400	360
5	254	254	216.0	186	8-22	3	24	255	550	405
6	267	279	241.5	216	8-22	3	26	285	550	425

Note: for more size please consult factory.